

# Empava

**30 inch electric wall oven**

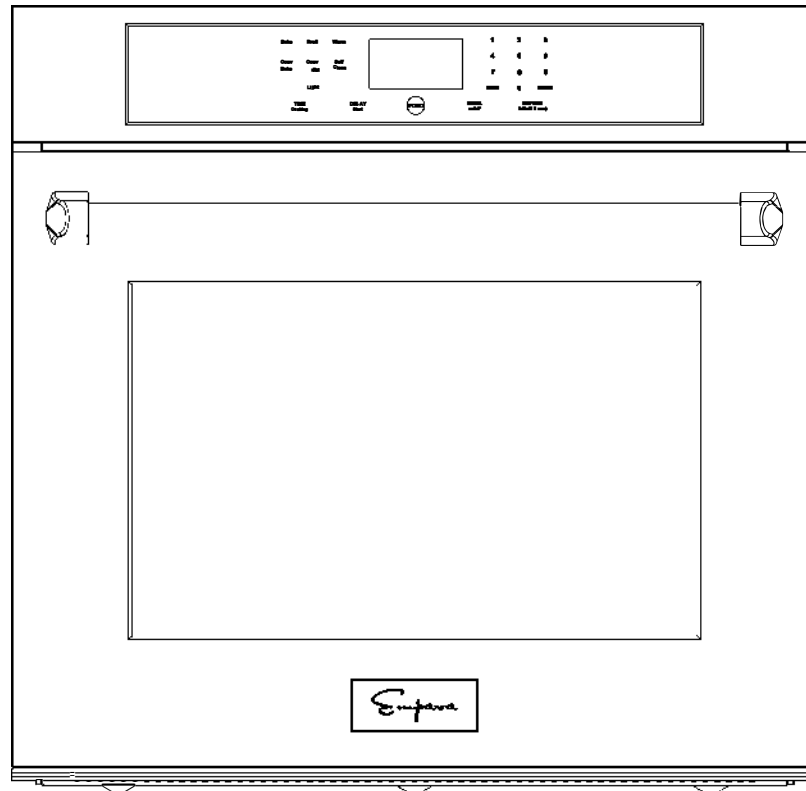

**MODEL NO:EMPV-30WO03**

## Contents

---

### Important safety instructions 13

---

Important safety instructions 13

### Install instructions 14

---

Location requirements 14

Install instructions 19

### Introducing your new oven 20

---

Overview 20

Energy saving tips 20

### Operating the oven 21

---

The oven control panel 21

Setting the clock 22

Setting the kitchen timer 22

Control Lockout 22

Timed Cooking 23

Delay Start 23

Turning the light on and off 23

Minimum and maximum settings 24

Using the oven racks 25

Baking 26

Convection baking 26

Convection roasting 27

Broiling 28

Using Keep Warm 28

Temp Probe 29

Using Options 31

### Maintaining your appliance 31

---

Self-cleaning 31

Care and cleaning of the oven 32

Using Sabbath 33

Removing the oven door 34

Replacing the oven door 35

Troubleshooting 36

Information codes 39

### Warranty 40

---

## Important safety instructions

Read and follow all instructions before using your oven to prevent the risks of fire, electric shock, personal injury, or damage when using the oven.

This guide does not cover all possible conditions that may occur.

Always contact your service agent or the manufacturer about problems that you do not understand.

## WHAT YOU NEED TO KNOW ABOUT SAFETY INSTRUCTIONS

Warnings and important safety instructions in this manual do not cover all possible conditions and situations that may occur. It is your responsibility to use common sense, caution, and care when installing, maintaining, and operating your oven.

### Important safety symbols and precautions

What the icons and signs in this user manual mean:

#### **WARNING**

Hazards or unsafe practices that may result in **severe personal injury or death**.









#### **CAUTION**

Hazards or unsafe practices that may result in **minor personal injury or property damage**.

## SAVE THESE INSTRUCTIONS

#### **CAUTION**

To reduce the risk of fire, explosion, electric shock, or personal injury when using your oven, follow these basic safety precautions.

-  Do NOT attempt.
-  Do NOT disassemble.
-  Do NOT touch.
-  Follow directions explicitly.
-  Unplug the power plug from the wall socket.
-  Make sure the machine is grounded to prevent electric shock.
-  Call Empava service center for help.
-  Note

These warning signs are here to prevent injury to you and others. Please follow them explicitly. After reading this section, keep it in a safe place for future reference.

## SAVE THESE INSTRUCTIONS

## Important safety instructions

### STATE OF CALIFORNIA PROPOSITION 65 WARNING (US ONLY)

WARNING : This product contains chemicals known to the State of California to cause cancer and birth defects or other reproductive harm.

### FOR YOUR SAFETY

When using electrical appliances, you should follow basic safety precautions, including the following:

#### CAUTION

- Use this appliance only for its intended purpose as described in this Owner's Manual.
- Potentially hot surfaces include the oven vent opening, surfaces near the opening, and crevices around the oven door.

 **Proper Installation** - Be sure your appliance is properly installed and grounded by a qualified technician.

 **User servicing** - Do not repair or replace any part of the appliance unless specifically recommended in this manual. All other servicing should be referred to a qualified technician.

→ Always disconnect the power to the appliance before servicing by removing the fuse or switching off the circuit breaker.

 • **Do not enter the oven.**

• **Do not leave children alone.** Never leave children alone or unattended in an area where this appliance is in use. They should never be allowed to sit or stand on any part of the appliance.

• **Never use your appliance for warming or heating the room.**

• **Do not use water on grease fires.** Turn off the oven to avoid spreading the flames. Smother the fire or flames by closing the door or use a dry chemical, baking soda, or foam-type extinguisher.

• Avoid scratching or striking the glass doors and the control panel. Doing so may lead to glass breakage. Do not cook on a product with broken glass. Shock, fire, or cuts may occur.

- 
- ☒ • If there is a fire in the oven during self-cleaning, turn the oven off and wait for the fire to go out. Do not force the door open. The introduction of fresh air at self-cleaning temperatures may lead to a burst of flame from the oven.

Failure to follow these instructions may result in severe burns.

- If the oven is heavily soiled with oil, self-clean the oven before using the oven again. Leaving the oil in place creates a risk of fire.
- Wipe up heavy soil on the oven bottom with a paper towel or rag before self-cleaning. Self-cleaning the oven when there is heavy soil on the oven bottom requires longer cleaning cycles and produces more smoke.
- ★ • **Storage in or on the appliance.** Do not store flammable materials in the oven or near the surface units. Be sure all packing materials are removed from the appliance before operating it. Keep plastics, clothes, and paper away from parts of the appliance that may become hot.
- **Wear proper apparel.** Never wear loose-fitting or hanging garments while using the appliance.

- 
- ★ • **Use only dry potholders.** Placing moist or damp potholders on hot surfaces may result in burns from steam. Do not let the potholder touch hot heating elements. Do not use a towel or other bulky cloth instead of a potholder.
  - Teach children not to play with the controls or any other part of the oven.
  - For your safety, do not use high-pressure water cleaners or steam jet cleaners to clean any part of the oven.
  - If the power cord is damaged, it must be replaced by the manufacturer, its service agent, or similarly qualified persons to avoid creating a hazard.
  - The appliance is not intended for use by persons (including children) with reduced physical, sensory or mental capabilities, or lack of experience and knowledge, unless they have been given supervision or instruction concerning use of the appliance by a person responsible for their safety.

## Important safety instructions

---

### ELECTRICAL SAFETY

---

- ★ • Use only the factory installed flexible power cord to connect to the power supply. Do not use a 3rd party power supply cord kit.
- The appliance should be serviced only by qualified service personnel. Repairs carried out by unqualified individuals may cause injury or a serious malfunction. If your appliance is in need of repair, contact a Empava authorized service center. Failure to follow these instructions may result in damage and void the warranty.
  - Flush - mounted appliances may be operated only after they have been installed in cabinets and workplaces that conform to the relevant standards. This ensures that the appliances are installed in compliance with the appropriate safety standards.
- If your appliance malfunctions or if fractures, cracks, or splits appear:
  - Switch off the oven.
  - Unplug the oven from the AC wall outlet.
  - Contact your local Empava service center.

### ⚠ WARNING

- Ensure that the appliance is switched off before replacing the lamp to avoid the possibility of electric shock.

### CHILD SAFETY

---

### ⚠ WARNING

- This appliance is not intended for use by young children or infirm persons without the adequate supervision of a responsible adult.
- Young children should be supervised to ensure that they do not play with the appliance.
- Keep children away from the door when opening or closing it as they may bump themselves on the door or catch their fingers in the door.
- During self-cleaning, the surfaces may get hotter than usual. Keep small children away from the oven when it is in the selfcleaning mode.

### ⚠ WARNING

Accessible parts may become hot during use. To avoid burns, young children should be kept away.

---

## OVEN

---

- ☒ • **DO NOT TOUCH THE HEATING ELEMENTS OR INTERIOR SURFACES OF THE OVEN.** Heating elements may be hot even though they are dark in color. Interior surfaces of an oven become hot enough to cause burns. During and after use, do not touch or let clothing or other flammable materials contact the heating elements or interior surfaces of the oven until they have had sufficient time to cool.
- Other surfaces of the appliance may become hot enough to cause burns. Among these surfaces are oven vent openings and surfaces near these openings, the oven door, and the window of the oven door.
- **Do not heat unopened food containers.** The build-up of pressure may cause the container to burst and result in injury.
- **Do not use the oven to dry newspapers.** If overheated, newspapers can catch fire.
- **Do not use the oven for a storage area.** Items stored in an oven can ignite.

- ★ • **Use care when opening the door.** Let hot air or steam escape before you remove food from or put food into the oven.
- **Protective liners.** Do not use aluminum foil to line the oven bottoms, except as suggested in this manual. Improper installation of these liners may result in a risk of electric shock or fire.
- **Placement of oven racks.** Always place oven racks in the desired location while the oven is cool. If the rack must be moved while the oven is hot, use potholders. Do not let the potholders come in contact with the hot heating element in the oven.
- ☒ • Do not allow aluminum foil or a meat probe to contact the heating elements.
- ☒ • **During use, the appliance becomes hot.** Care should be taken to avoid touching heating elements inside the oven.
- Do not use harsh abrasive cleaners or sharp metal scrapers to clean the oven door glass. They can scratch the surface which may result in the glass shattering.

## Important safety instructions

---

### CAUTION

Do not attempt to operate the oven during a power failure. If the power fails, always turn the oven off. If the oven is not turned off and the power returns, the oven may begin to operate again. Food left unattended could catch fire or spoil.

### SELF-CLEANING OVENS

---

 **Do not clean the door gasket.** The door gasket is essential for a good seal. Care should be taken not to rub, damage, or move the gasket.

-  • **Never keep pet birds in the kitchen.** Birds are extremely sensitive to the fumes released during an oven self-clean cycle. Fumes may be harmful or fatal to birds. Move birds to a well-ventilated room.
- **Clean only the parts listed in this manual in the self-clean cycle.** Before self-cleaning the oven, remove the partition, rack, utensils, and any food.
- Before operating the self-clean cycle, wipe grease and food soils from the oven. Excessive amounts of grease may ignite, leading to smoke damage to your home.

-  • Do not use any commercial oven cleaner or oven liner protective coating of any kind in or on the outside of the oven.
- Remove the nickel oven shelves from the oven before you begin the self-cleaning cycle or they may discolor.
- If the self-cleaning mode malfunctions, turn the oven off and disconnect the power supply. Have it serviced by a qualified technician.
- Excess spillage must be removed before you run the selfcleaning cycle.









---

## CRITICAL INSTALLATION WARNINGS

---

### WARNING

-  • This appliance must be installed by a qualified technician or service company.
  - Failing to have a qualified technician install the oven may result in electric shock, fire, an explosion, problems with the product, or injury.
- Unpack the oven, remove all packaging material and examine the oven for any damage such as dents on the interior or exterior of the oven, broken door latches, cracks in the door, or a door that is not lined up correctly. If there is any damage, do not operate the oven and notify your dealer immediately.
- Keep all packaging materials out of the reach of children. Children may use them for play and injure themselves.
-  • This appliance must be properly grounded.
  - Do not ground the appliance to a gas pipe, plastic water pipe, or telephone line.
    - This may result in electric shock, fire, an explosion, or problems with the product.

-  • Do not cut or remove the ground prong from the power cord under any circumstances.
  - Connect the oven to a circuit that provides the correct amperage.
-  • Do not install this appliance in a humid, oily or dusty location, or in a location exposed to direct sunlight or water (rain drops).
  - This may result in electric shock or fire.
- Do not use a damaged power cord or loose wall socket.
  - This may result in electric shock or fire.
- Do not pull or excessively bend the power cord.
- Do not twist or tie the power cord.
-  • Do not hook the power cord over a metal object, place a heavy object on the power cord, or insert the power cord between objects.
  - This may result in electric shock or fire.
-  If the power cord is damaged, contact your nearest Empava service center.



## Important safety instructions

### CRITICAL USAGE WARNING

#### CAUTION

-  • If the appliance is flooded by any liquid, please contact your nearest Empava service center. Failing to do so may result in electric shock or fire.
- If the appliance produces a strange noise, a burning smell, or smoke, unplug the power plug immediately and contact your nearest Empava service center.
  - Failing to do so may result in electric shock or fire
- In the event of a gas leak (such as propane gas, LP gas, etc.), ventilate the area immediately. Do not touch the power cord. Do not touch the appliance.
  - A spark may result in an explosion or fire.
- Take care not to contact the oven door, heating elements, or any of the other hot parts with your body while cooking or just after cooking.
  - Failing to do so may result in burns.
- If materials inside the oven should ignite, keep the oven door closed, turn the oven off and disconnect the power cord, or shut off power at the fuse or circuit breaker panel. If the door opened, the fire may spread.

## SAVE THESE INSTRUCTIONS

-  • Always observe safety precautions when using your oven. Never try to repair the oven on your own - there is dangerous voltage inside. If the oven needs to be repaired, contact an authorized Empava service center near you.
- If you use the appliance when it is contaminated by foreign substances such as food waste, it may result in a problem with the appliance.
- Take care when removing the wrapping from food taken out of the appliance.
  - If the food is hot, hot steam may be emitted abruptly when you remove the wrapping and this may result in burns.
-  • Do not attempt to repair, disassemble, or modify the appliance yourself.
  - Since a high voltage current enters the product chassis, it may result in electric shock or fire.
  - When a repair is needed, contact your nearest Empava service center.
-  • If any foreign substance such as water has entered the appliance, contact your nearest Empava service center.
  - Failing to do so may result in electric shock or fire.

## SAVE THESE INSTRUCTIONS

- 
- ☒ • Do not touch the power cord with wet hands.
    - This may result in electric shock.
  - Do not turn the appliance off while an operation is in progress.
    - This may cause a spark and result in electric shock or fire.
  - Do not let children or any person with reduced physical, sensory, or mental capabilities use this appliance unsupervised.
  - Make sure that the appliance's controls and cooking areas are out of the reach of children.
    - Failing to do so may result in electric shock, burns, or injury.
  - Do not touch the inside of the appliance immediately after cooking. The inside of the appliance will be hot.
    - Failing to do so may result in burns.
  - Do not use or place flammable sprays or objects near the oven.
    - Flammable items or sprays can cause fires or an explosion.

- 
- ☒ • Do not insert fingers, foreign substances, or metal objects such as pins or needles into inlets, outlets, or holes. If foreign substances are inserted into any of these holes, contact your product provider or nearest Empava service center.
  - Do not tamper with or make any adjustments or repairs to the door. Under no circumstances should you remove the door or outer shell of the oven.
  - Do not store or use the oven outdoors.
  - Never use this appliance for purposes other than cooking.
    - Using the appliance for any purpose other than cooking may result in fire.
  - Open the cap or stopper of sealed containers (herb tonic tea bottle, baby bottle, milk bottle and so on) before heating them. Make a hole in food items that have shells (eggs, chestnuts, etc) with a knife before cooking them.
    - Failing to do so may result in burns or injury.
  - Never heat plastic or paper containers and do not use them for cooking.
    - Failing to do so may result on fire.

## Important safety instructions

---

- Do not heat food wrapped in paper from magazines, newspapers, etc.
  - This may result in fire.
- Do not open the door when the food in the oven is burning.
  - If you open the door, it causes an inflow of oxygen and may cause the food to ignite.
- Do not apply excessive pressure to the door or the inside of the appliance. Do not strike the door or the inside of the appliance.
  - Hanging on to the door may result in the product falling and cause serious injury.
  - If the door is damaged, do not use the appliance. Contact a Empava service center.
- Do not hold food in your bare hands during or immediately after cooking.
  - Use cooking gloves. The food may be very hot and you could burn yourself.
  - As the handle and oven surfaces may be hot enough to cause burns after cooking, use cooking gloves to protect your hands from burns.

## USAGE CAUTIONS

---

### CAUTION

-  If the surface is cracked, turn the appliance off.
  - Failing to do so may result in electric shock.
- Dishes and containers can become hot. Handle with care.
- Hot foods and steam can cause burns. Carefully remove container coverings, directing the steam away from your hands and face.
- Remove lids from baby food jars before heating. After heating baby food, stir well to distribute the heat evenly. Always test the temperature by tasting before feeding the baby. The glass jar or the surface of the food may appear to be cooler than the interior, which can be hot enough to burn an infant's mouth.
- Take care as beverages or food may be very hot after heating.
  - Especially when feeding a child, make sure the food or beverage has cooled sufficiently.

- 
- ★ • Take care when heating liquids such as water or other beverages.
    - Make sure to stir during or after cooking.
    - Avoid using a slippery container with a narrow neck.
    - Wait at least 30 seconds after heating before removing the heated liquid.
    - Failing to do so may result in an abrupt overflow of the contents and cause burns.
  
  - ☐ • Do not stand on top of the appliance or place objects (such as laundry, an oven cover, lighted candles, lighted cigarettes, dishes, chemicals, metal objects, etc.) on the appliance.
    - Items, such as a cloth, may get caught in the door.
    - This may result in electric shock, fire, problems with the product, or injury.
  
  - Do not operate the appliance with wet hands.
    - This may result in electric shock.
  
  - Do not spray volatile substances such as insecticide onto the surface of the appliance.
    - As well as being harmful to humans, it may also result in electric shock, fire, or problems with the product.

- 
- ☐ • Do not put your face or body close to the appliance while cooking or when opening the door just after cooking.
    - Take care that children do not come too close to the appliance.
    - Failing to do so may result in children burning themselves.
  
  - Do not place food or heavy objects over the edge of the oven door.
    - If you open the door, the food or object may fall and this may result in burns or injury.
  
  - Do not abruptly cool the door, the inside of the appliance, or a dish by pouring water over it during or just after cooking.
    - This may result in damage to the appliance. The steam or water spray may result in burns or injury.
  
  - Do not operate while empty except for self-cleaning.
  
  - Do not defrost frozen beverages in narrow-necked bottles. The bottles can break.
  
  - Do not scratch the glass of the oven door with a sharp object.
    - This may result in the glass being damaged or broken.
  
  - Do not store anything directly on top of the appliance when it is in operation.

## Important safety instructions

---

- Do not use sealed containers. Remove seals and lids before cooking. Sealed containers can explode due to the build up of pressure even after the oven has been turned off.
- Take care that food you are cooking in the oven does not come into contact with the heating element.
  - This may result in fire.
- Do not over-heat food.
  - Overheating food may result in fire.
- Use caution when opening or closing the door. Your fingers may be pinched, resulting in physical injury.
- The door reveals wires at the bottom for connecting LED lights. So use caution not to pull or cut the wires when handling the door.

## CRITICAL CLEANING WARNINGS

---

### CAUTION

- Do not clean the appliance by spraying water directly on to it.
- Do not use benzene, thinner, or alcohol to clean the appliance.
  - This may result in discoloration, deformation, damage, electric shock, or fire.
- Take care not to hurt yourself when cleaning the appliance (externally or internally).
  - You may hurt yourself on the sharp edges of the appliance.
- Do not clean the appliance with a steam cleaner.
  - This may result in corrosion.
- Keep the inside of the oven clean. Food particles or spattered oils stuck to the oven walls or floor can cause paint damage and reduce the efficiency of the oven.

## Location requirements

**IMPORTANT:** Observe all governing codes and ordinances.

- Cabinet opening dimensions that are shown must be used. Given dimensions provide minimum clearance with oven.
- Recessed installation area must provide complete enclosure around the recessed portion of the oven.
- Grounded electrical supply is required. See “Electrical Requirements” section.
- Electrical supply junction box should be located 3” (7.6 cm) maximum below the support surface when the oven is installed in a wall cabinet. A 1” (2.5 cm) minimum diameter hole should have been drilled in the right rear or left rear corner of the support surface to pass the appliance cable through to the junction box.

### NOTE

For under counter installation, it is recommended that the junction box be located in the adjacent right or left cabinet. If you are installing the junction box on rear wall behind oven, it is recommended that the junction box be recessed and located in the upper Right of the cabinet.

- Oven support surface must be solid, level and flush with bottom of cabinet cutout.
- Floor must be able to support a single oven weight of 199 lb (90 Kg).
- Floor must be able to support a double oven weight of 331 lb (150 Kg).

**IMPORTANT:** To avoid damage to your cabinets, check with your builder or cabinet supplier to make sure that the materials used will not discolor, delaminate or sustain other damage. This oven has been designed in accordance with the requirements of UL and CSA International and complies with the maximum allowable wood cabinet temperatures of 194 °F (90 °C).

## Product dimension

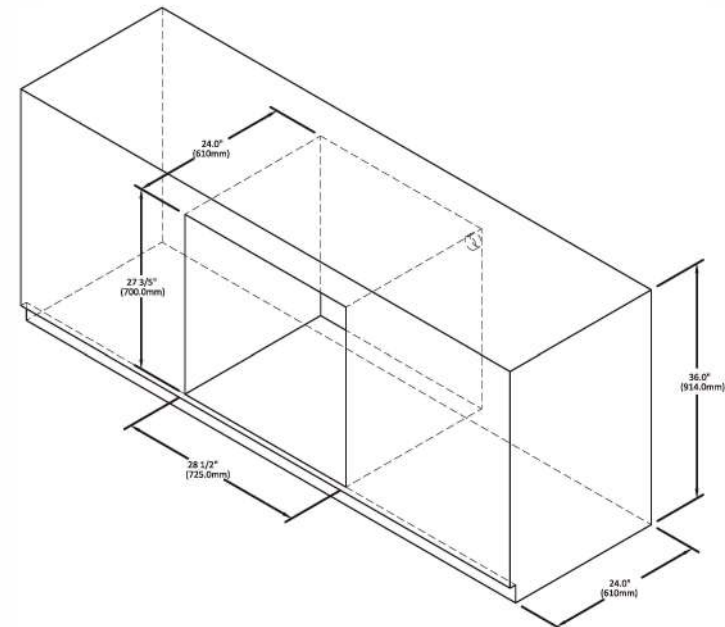
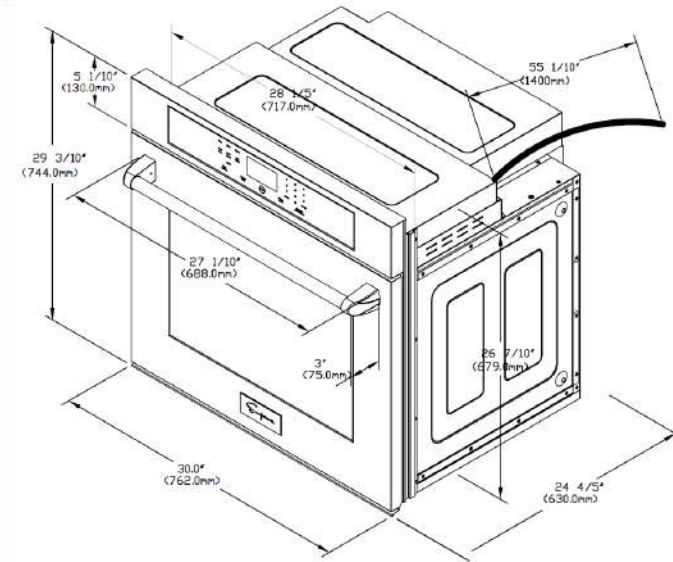

## Installation instructions

---

Oven installed in Cabinet

A.24"(61cm) cutout depth

B.27-3/5(70cm) recommended cutout height.

C.28-1/2(72.5cm) cutout width

D.24"(61cm) Min.cabinet depth

E.36"(91.4cm)Min. cabinet height

### Prepare built-in oven

---

#### **WARNING**

Excessive Weight Hazard

Use two or more people to move and install an oven.

Failure to do so can result in back or other injury.

1. Decide on the final location for the oven.Avoid drilling or cutting into house wiring during installation.
2. To avoid floor damage,set the oven on a cardboard prior to installation.Donot use handle or any portion of the front frame for lifting.
3. Remove the shipping materials and tape from the oven.  
Remember to keep the packing materials that may be needed for installation.
4. Remove the hardware package from inside of the bag containing literature.
5. Remove racks and other parts from inside the oven.
6. Move oven and cardboard close to the oven's final location.

## Installation instructions

---

### Remove and replace oven door

---

**IMPORTANT:** Use two hands to remove oven door.

Prior to removing the oven door, prepare a surface where you will place it.

This surface should be flat and covered with a soft blanket, or use the corner posts from your packaging material.



### Remove oven door

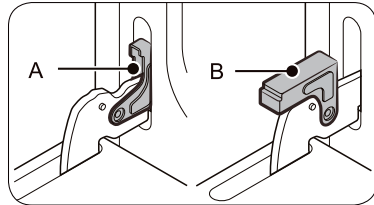

A. Oven door hinge lock in locked position  
B. Oven door hinge lock in unlocked position

1. Open the oven door.
2. Locate the oven door hinge lock in both corners of the oven door, and then rotate the hinge locks toward the oven door to the unlocked position (see illustration B). If the door hinge lock is not rotated fully, the door will not remove properly.

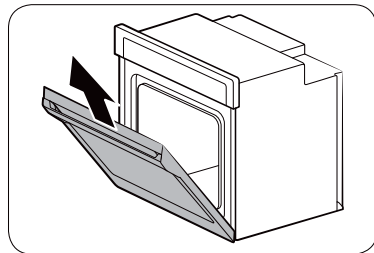

3. Partially close the door to engage the door latch locks. The door will stop at this point.

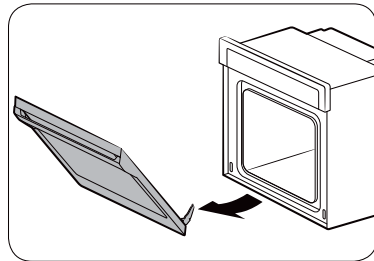

4. Using two hands, grasp the edges of the oven door. Lift and pull the oven door toward you and remove. You may need to gently shift door from side to side as you pull.
5. Set the oven door(s) aside on the prepared covered work surface with the oven door resting on its handle.
6. To continue with the oven installation, go to the "Positioning Oven Feet for Multiple Cabinet Cutout Heights" section.

### Replace oven door

#### **CAUTION**

The door is very heavy. You may need help lifting the door high enough to slide it into the hinge slots. Do not lift the door by the handle.

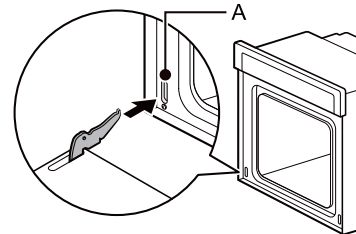

A. Slot in the oven cavity for door hinge lock

1. Using two hands, grasp side edges of door at the midpoint. Face the oven cavity.
2. Locate the slots on each side of the oven cavity for the door hinge locks.

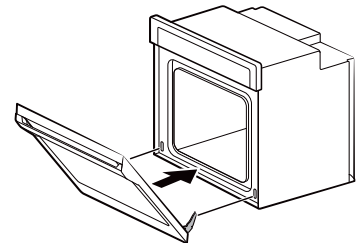

3. At a 45° angle, align door hinges with slots in the lower front of the oven cavity. Slowly insert door, making sure you maintain the 45° angle. You will know the door is engaged in the slot when you feel a slight drop.

## Installation instructions

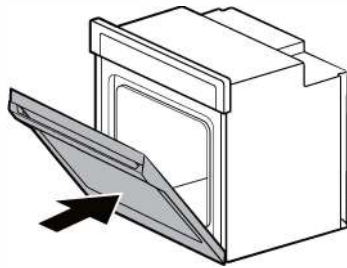

4. Lower the oven door to the fully open position. If the oven door does not open to a full 90°, repeat steps 1 through 3.
5. Locate the oven door hinge locks in the corners of the oven door, and rotate the hinge locks toward the oven cavity to the locked position. See Step 1 (illustration A) in the “Remove Oven Door(s)” section for proper locked position.
6. Close the oven door.
7. When the hinges are properly installed and the door closed, there should be an even gap between the door and the control panel. If one side of the oven door is hanging lower than the other, the hinge on that side is not properly installed.
8. Connect Wire Harness.

## Installation instructions

### Electrical Connection Options Chart

If your home has:	Go to section:
	4-Wire Cable from Home Power Supply
	3-Wire Cable from Home Power Supply

# Installation instructions

## 4-Wire Cable from Home Power Supply

**IMPORTANT:** Use the 4-wire cable from home power supply in the U.S. where local codes do not allow grounding through neutral, New Branch circuit installations (1996 NEC), mobile homes and recreational vehicles, new construction and in Canada.

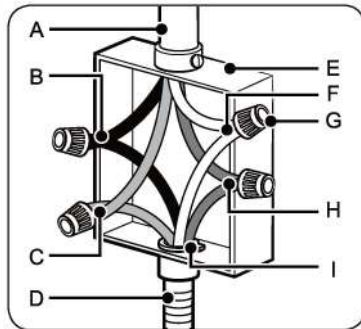

- A. Cable from home power supply
- B. Black wires (normally L1)
- C. Red wires (normally L2)
- D. 4-wire flexible conduit from oven
- E. Junction box
- F. White wires (normally N-neutral)
- G. UL listed wire connectors
- H. green wires (normally G-ground)
- I. UL listed or CSA approved conduit connector

1. Connect the 2 black wires (B) together using a UL listed wire connector.
2. Connect the 2 red wires (C) together using a UL listed wire connector.
3. Untwist white wire from green (or bare) ground wire coming from the oven.
4. Connect the 2 white wires (F) together using a UL listed wire connector.
5. Connect the green (or bare) ground wire (H) from the oven cable to the green (or bare) ground wire (in the junction box) using a UL listed wire connector.
6. Install junction box cover.

## 3-Wire Cable from Home Power Supply - U.S. Only

**IMPORTANT:** Use the 3-wire cable from home power supply where local codes permit a 3-wire connection.

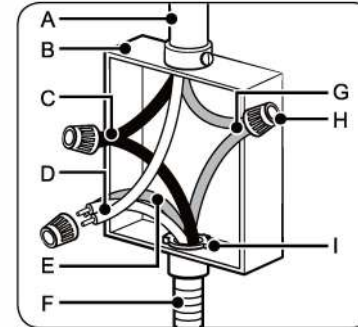

- A. Cable from home power supply
- B. Junction box
- C. Black wires (normally L1)
- D. White wires (normally N-neutral)
- E. green wires (normally G-ground)
- F. 4-wire flexible conduit from oven
- G. Red wires (normally L2)
- H. UL listed wire connectors
- I. UL listed or CSA approved conduit connector

1. Connect the 2 black wires (C) together using a UL listed wire connector.
2. Connect the 2 white wires (D) and the green (or bare) ground wire (of the oven cable) using a UL listed wire connector.
3. Connect the 2 red wires (G) together using a UL listed wire connector.
4. Install junction box cover.

## Install oven handle

1 How to install Handles For Empava KD Models

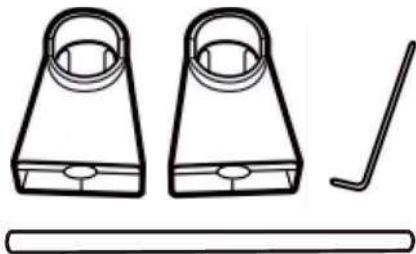

2 \* Handle Holders, 1 \* Installation Wrench, 1\*Handle

2 Connect the handle to the handle holders.



3 Lay the door handle against to the oven door and fit it on the connection part.

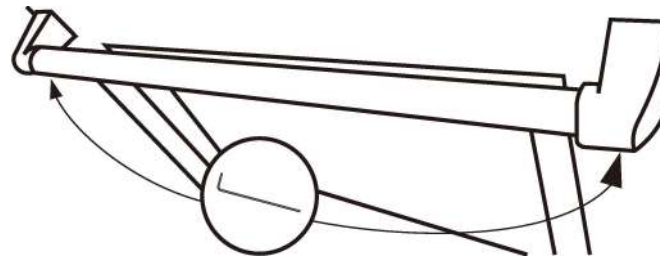

4 Use the wrench to get the door handle holder tight

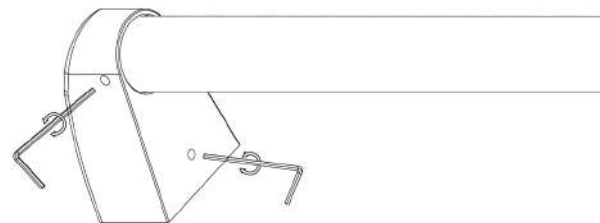

5 Check if the oven door is level and stable.

# Introducing your new oven

## Overview

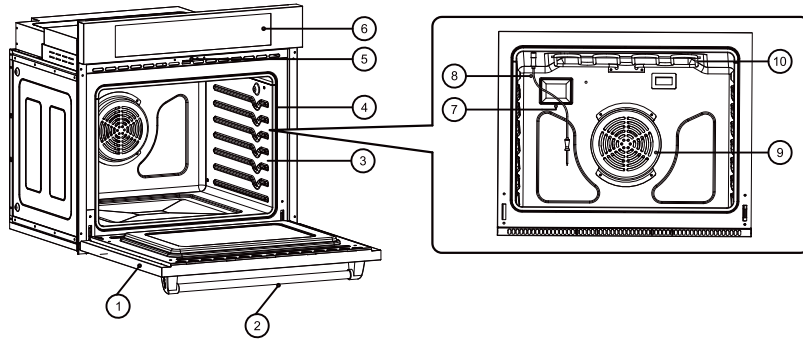

- |                 |                |                       |
|-----------------|----------------|-----------------------|
| 01 Oven door    | 02 Oven handle | 03 Shelf position     |
| 04 Oven gasket  | 05 Door latch  | 06 Oven control panel |
| 07 Halogen lamp | 08 Temp Probe  | 09 Convection fan     |
|                 |                | 10 Heating elements   |

## What's included with your oven

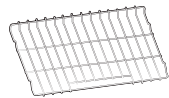

Wire racks (2)\*

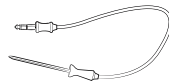

Temp Probe(1)\*

# Before you begin

Clean the oven thoroughly before using it for the first time. Then, remove the accessories, set the oven to Bake, and then run the oven at 400 °F for 1 hour. There will be a distinctive odor. This is normal.

Ensure your kitchen is well ventilated during this conditioning period.

## Energy saving tips

- During cooking, the oven door should remain closed except when you turn food over.  
Do not open the door frequently during cooking to maintain the oven temperature and to save energy.
- If cooking time is more than 30 minutes, you can switch the oven off 5-10 minutes before the end of the cooking time to save energy. The residual heat will complete the cooking process.
- To save energy and reduce the time needed for re-heating the oven, plan oven use to avoid turning the oven off between cooking one item and the next.
- Whenever possible, cook more than one item at a time.

## Operating the oven

### The oven control panel

**READ THE INSTRUCTIONS CAREFULLY BEFORE USING THE OVEN.**

For satisfactory use of your oven, become familiar with the various features and functions of the oven as described below. **Detailed instructions for each feature and function follow later in this user manual.**

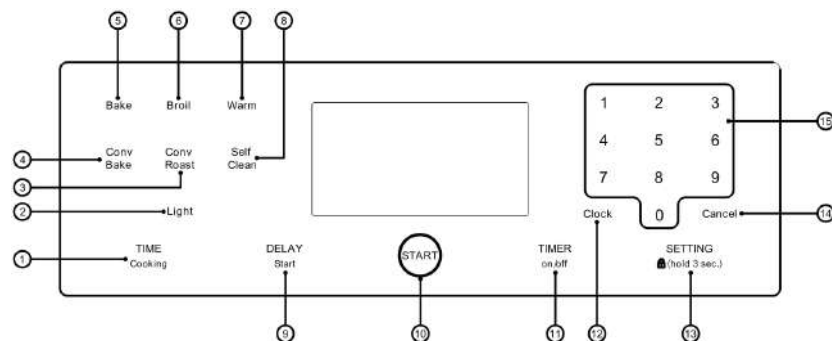

1. **Time Cooking:** Touch and then use the number pad to set the amount of time you want your food to cook. The oven will shut off when the cooking time has run out.
2. **Light:** Use to turn the light (Oven and Door) on or off.
3. **Convection Roast:** Use to select the Convection Roast function.
4. **Convection Bake:** Use to select the Convection Bake function.
5. **Bake:** Use to select the Bake function.
6. **Broil:** Use to select the Broil function.
7. **Warm:** Use to select the Warm function to keep cooked foods.
8. **Self Clean:** Use to select the Self-cleaning function. While Self-cleaning is running in one oven, you cannot use the other oven for any function.
9. **Delay Start:** Use to set the oven to start and stop automatically at a time you set.

**10.START:** Use to start any cooking or cleaning function in the oven.

**11.Timer On/Off:** Use to set or cancel the kitchen timer. The kitchen timer does not start or stop cooking.

**12.Clock:** Use to set the time of day.

**13.SETTING/Lock(3sec):** Use to disable all oven functions.

**14.Cancel:** Use to cancel a previously entered temperature or time.

**15.Number pad:** Use to set any function requiring numbers such as the time of day on the clock, the timer, the oven temperature, the start time, and the length of operation for timed baking, etc.

# Operating the oven

## Setting the clock

The clock must be set to the correct time of day for the automatic oven timing functions to work properly.

- The time of day cannot be changed during timed cooking, delay-timed cooking, or a self-cleaning cycle.
- You can choose between a 12-hour or 24-hour display. The default is 12-hour.

### How to set the clock

1. Touch **Clock**.
2. Touch **Clock** to select AM or PM. (Skip this step if you are setting the clock to 24 hour display mode.)
3. Touch keys in the **number pad** to set the current time of day.
4. Touch **START** to save the changes.

## Setting the kitchen timer

The kitchen timer serves as an extra timer that will beep when the set time has elapsed. It does not start or stop cooking functions. You can use the kitchen timer with any of the other oven functions.

### How to set the timer

1. Touch **Timer On/Off**.
2. Touch number keys in the **number pad** to set the hours and minutes. The timer can be set for any amount of time from 1 minute to 11 hours and 59 minutes. If you make a mistake, touch **Cancel**, and then enter the amount of time again.
3. Touch **START**.
4. When the set time has elapsed, the oven will beep and the display will show End until you touch **Timer On/Off**. You can cancel the timer at any time by touching **Timer On/Off**.

## Control Lockout

Control Lockout lets you lock the buttons on the touch pad so they cannot be activated accidentally. You can only activate Control Lockout when the oven is in standby mode.

### How to activate the Control Lockout

1. Cancel or turn off all other functions.
2. Touch **SETTING Lock( hold 3 sec.)** for 3 seconds. The oven will display "**Loc**" and the lock icon along with the current time.

### NOTE

- All other functions must be cancelled before you activate Control Lockout.

### How to unlock the controls

Touch **SETTING Lock( hold 3 sec.)** for 3 seconds. "**Loc**" and the lock icon will disappear from the display.

## Time cooking

In Timed Cooking mode, the oven turns on immediately and cooks for the length of time you select. At the end of the cooking time, the oven turns off automatically.

- You can use the Timed Cooking only with another cooking operation (Convection Bake, Convection Roast, Bake).

### How to set the oven for Time Cooking

- Touch the pad for the cooking operation you want, eg. **Bake**.  
Enter the temperature you want, for example, 400 °F, using the number pad. (The default temperature is 350 °F).
- Touch **Time Cooking**. Enter the number of hours/minutes you want the oven to
- stay on using the **number pad**. You can set the cooking time for any amount of time from 1 minute to 11 hours and 59 minutes. Touch **START** to begin cooking. The temperature display will start to change once the oven temperature reaches 100 °F. The oven will continue to cook until the set amount of time has elapsed, then turn off automatically unless you set the Keep Warm feature. (Refer to the Using Keep Warm section on page 30.)

-  When Timed Cooking is done, the oven will beep 3 times.

## CAUTION

Use caution with the **Time Cooking** or **Delay Start** features. You can use these features to cook cured or frozen meats and most fruits and vegetables. For food that can easily spoil, such as milk, eggs, and unfrozen or fresh fish, meat, or poultry, chill them in the refrigerator first. Even when chilled, they should not stand in the oven for more than 1 hour before cooking begins, and should be removed promptly when cooking is completed. Eating spoiled food can result in sickness from food poisoning.

## Operating the oven

### Delay Start

With Delay Start, the oven's timer turns the oven on and off at times you select in advance.

- You can use the Delay Start only with another cooking operation (Convection Bake, Convection Roast, Bake).
- You can set the oven for a delay start before setting other cooking operations. The clock must be set to the current time.

### How to set the oven for delay start

- Position the oven rack(s) and place the food in the oven.
- Touch the pad for the cooking operation you want, eg. **Bake**.  
The default temperature is 350 °F.
- Enter the temperature you want, eg. 375 °F, using the **number pad**.
- Set the cooking time if you want. (Refer to the section on the timed cooking feature on page 21).
- Touch **Delay Start**. Use the **number pad** to set the time.
- Touch **START**. The oven will begin to cook.







### Turning the light on and off

- The oven light turns on and door light turns off automatically when the door is opened.
- The oven light turns off automatically when the door is closed.
- You can turn the oven and door light on and off manually by touching the *Light*.



## Minimum and maximum settings

All the features listed in the table below have minimum and maximum time or temperature settings. A beep will sound each time a pad on the control panel is pressed and the entry is accepted. An error tone will sound in the form of a long beep if the entered temperature or time is below the minimum or above the maximum setting for the feature.

	FEATURE	MINIMUM	MAXIMUM
	Bake	150 °F(65 °C)	550 °F(285 °C)
	Broil	LO	HI
	Convection Bake	150 °F(65 °C)	550 °F(285 °C)
	Convection Roast	150 °F(65 °C)	550 °F(285 °C)
	Self Clean	2 Hr.	5 Hr.
	Keep Warm	-	3 Hr.

## Using the oven racks

### Oven rack positions

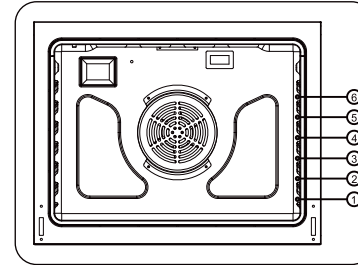

Recommended rack position for cooking

TYPE OF FOOD	RACK POSITION
Broiling hamburgers	6
Broiling meats or small cuts of poultry, fish	3-5
Bundt cakes, pound cakes, frozen pies, casseroles	4 or 3
Angel food cakes, small roasts	2
Turkey, large roast, hams, fresh pizza	1

- This table is for reference only.

### Rack and Pan placement

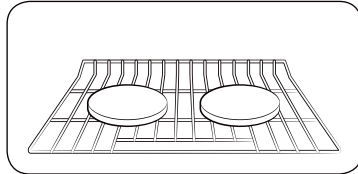

Single Oven Rack

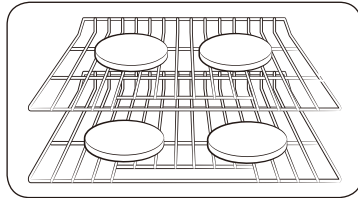

Multiple Oven Rack

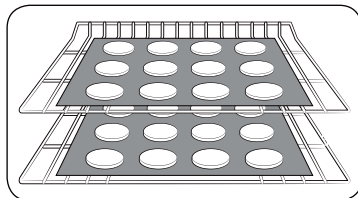

Multiple Oven Rack

Centering baking pans in the oven as much as possible will produce better results. If baking with more than one pan, place the pans so each has at least 1" to 1½" of air space around it. When baking on a single oven rack, place the oven rack in position 3 or 4. See the figure on the left. When baking cakes and cookies on multiple racks, place the oven racks in position 3 and 5. Using Multiple Oven Racks

Type of Baking	Rack Positions
Cakes and cookies	3 and 5

## Operating the oven

### Before using the racks

Each rack has stops that need to be placed correctly on the supports. These stops will keep the rack from coming completely out.

### REMOVING THE RACKS

1. Pull the rack straight out until it stops.
2. Lift up the front of the rack, and then pull it out.

### REPLACING THE RACKS

1. Place the end of the rack on the support.
2. Tilt the front end up and push the rack in.

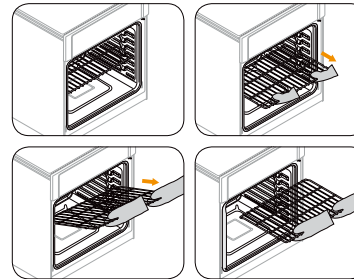

### CAUTION

- Do not cover a rack with aluminum foil or place aluminum foil on the oven bottom. This will hamper heat circulation, resulting in poor baking, and may damage the oven bottom.
- Arrange the oven racks only when the oven is cool.

## Baking

The oven can be programmed to bake at any temperature from 150 °F to 550 °F. Baking temperature and time will vary depending on the ingredients and the size and shape of the baking pan used. Dark or nonstick coatings may cook faster with more browning.

### How to set the oven for baking

1. Touch **Bake**.
  2. Enter the temperature you want using the **number pad**, eg. 3, 7, 5.
  3. Touch **START**. The temperature display will start to change once the oven temperature reaches 100 °F.
  4. If you want to cancel baking or if you have finished, touch **Cancel**.
- ★ • Place food in the oven after preheating if the recipe calls for it. Preheating is very important for good results when baking cakes, cookies, pastry, and breads. After the oven has reached the desired temperature, the oven will beep 3 times.

### NOTE

- If you are using an oven thermometer in the oven cavity, the temperature registered by the thermometer may differ from the actual set oven temperature.

## Operating the oven

### Convection baking

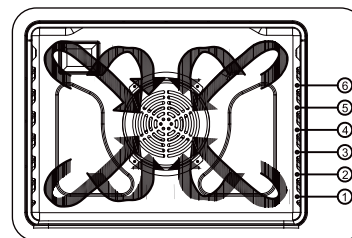

By using the Convection Bake, you will be able to cook faster. Convection baking uses a fan to circulate the oven's heat evenly and continuously within the oven. This improved heat distribution allows for even cooking and excellent results while using multiple racks at the same time. Foods cooked on a single oven rack will generally cook faster and more evenly with convection baking. Multiple oven rack cooking may have slightly increased cooking times for some foods, but the overall result is time saved. Breads and pastries brown more evenly. You can program the oven for convection baking at any temperature between 150 °F and 550 °F.

### Tips for convection baking

The amount of time you save will vary depending on the amount and type of food you are cooking. When baking cookies or biscuits, you should use pans with no sides or very low sides to allow the heated air to circulate around the food. Using a pan with a dark finish will produce faster cooking times.

When using convection baking with a single rack, place the oven rack in **position 3 or 4**. If cooking on multiple racks, place the oven racks in **position 3 and 5**. When baking a cake, using the bake mode (not the convection bake mode) will produce better results.

### How to set the oven for convection baking

1. Touch **Bake**.
2. Enter the temperature you want, eg. 400 °F, using the **number pad**.
3. Touch **START**.

The temperature display will start to change once the oven temperature reaches 100 °F.

The oven will beep 3 times when the oven reaches the adjusted oven temperature.

4. If you want to cancel convection baking or if you have finished, touch **Cancel**.

- ★ • The convection oven fan shuts off when the oven door is opened.
- DO NOT leave the door open for long periods of time while using convection cooking or you may shorten the life of the convection heating element.

#### NOTE

- If you leave the oven door open for more than 1 minute when the oven is on, all heating elements will shut off automatically.
- If you are using an oven thermometer in the oven cavity, the temperature registered by the thermometer may differ from the actual set oven temperature.

### Convection roasting

Convection roasting is good for cooking large tender cuts of meat uncovered. Heat comes from the top heating element. The convection fan circulates the heated air evenly over and around the food. Meat and poultry are browned on all sides as if they were cooked on a rotisserie. The heated air seals in juices quickly for moist and tender results while, at the same time, creating a rich golden brown exterior.

#### How to set the oven for convection roasting

1. Touch **Roast**.  
Enter the temperature you want, eg. 400 °F, using the **number pad**.
2. Touch **START**.
3. The temperature display will start to change once the oven temperature reaches 100°F. The oven will beep 3 times when the oven reaches the adjusted oven temperature.
4. If you want to cancel convection roasting or if you have finished, touch **Cancel**.

- ★ • The convection oven fan shuts off when the oven door is opened.
- DO NOT leave the door open for long periods of time while using convection cooking or you may shorten the life of the convection heating element.

#### NOTE

- If you leave the oven door open for more than 1 minute when the oven is on, all heating elements will shut off automatically.
- If you are using an oven thermometer in the oven cavity, the temperature registered by the thermometer may differ from the actual set oven temperature.

## Operating the oven

### Broiling

Broiling is a method of cooking tender cuts of meat by direct heat under the broil element of the oven.

The high heat cooks quickly and gives a rich, brown outer appearance. Broil mode is best for meats, fish, and poultry up to 1" thick.

#### How to set the oven for broiling

1. Touch **Broil** once for Hi or twice for Lo .  
Use Lo to cook foods such as poultry or thick cuts of meat thoroughly without over-browning them.
2. To start broiling, touch **START**.  
Broil one side until the food is browned. Turn over and broil the other side.
3. Touch **Cancel** once you have finished cooking or if you want to cancel broiling.

#### NOTE

- If you leave the oven door open for more than 1 minute when the oven is on, all heating elements will shut off automatically.
- If you are using an oven thermometer in the oven cavity, the temperature registered by the thermometer may differ from the actual set oven temperature.

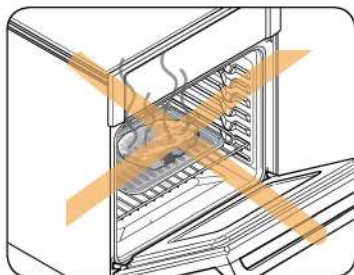

#### CAUTION

Always broil with the oven door closed. Use care when opening the door. Let hot air or steam escape before you remove food from or put food into the oven.

## Operating the oven

### Using Keep Warm

Keep Warm will keep cooked food warm for serving up to 3 hours after cooking has finished.

After 3 hours, the feature will shut off automatically. You can use the Keep Warm feature without any other cooking operations or you can set it to activate after a timed or delay timed cooking operation.

You should not use this feature to reheat cold food.

#### How to use Keep Warm

1. Touch **Keep Warm**.
2. Touch **START**.
3. Touch **Cancel** at any time to turn the feature off.

#### How to set the oven to activate Keep Warm after a time cooking

1. Set up the oven for **Time cooking**. (Refer to Timed Cooking section on page 21.)
2. Touch **Keep Warm** before touching **START** to begin cooking.
3. Touch **Cancel** at any time to turn the feature off.

## Using the Temp Probe

For many foods, especially roasts and poultry (beef, chicken, turkey, pork, lamb, etc), measuring the internal temperature is the best way to determine if the food is properly cooked.

The Temp Probe lets you cook meat to the exact internal temperature you want, taking the guess work out of determining whether a piece of meat is done or not. This function can be used with Bake, Convection Bake or Convection Roast. After the internal temperature of the food reaches 100 °F, the increasing internal temperature will be shown in the display.

### How to use the Temp Probe

1. Push the tip of the temp probe into the meat as fully as possible, so that the tip is in the center of the meat.

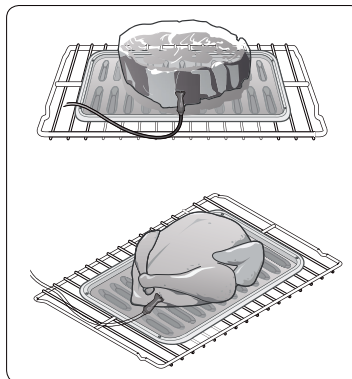

- Insert the probe completely into the meat as shown in the illustrations. It should not touch bone, fat, or gristle.
- If you do not fully insert the probe into the meat, the Temp Probe function will not work correctly because the probe will sense the oven temperature, not the temperature of the meat.
- For bone-in meats, insert the probe into the center of the lowest and thickest portion of the piece.
- For whole poultry (turkey, large chickens, etc.), insert the probe into the thickest part of the inner thigh, parallel to the leg.
- If you activate Keep Warm to keep the meat warm after you have cooked it using the Temp. Probe function, the meat's internal temperature will exceed the temperature you want.

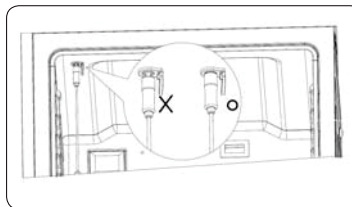

2. Insert the temp probe plug into the socket on the top side wall of the oven as far as it will go.

3. Select the desired cooking function (Bake or Convection Roast) and temperature
4. Touch **SETTING** to enter **Temp. Probe** (probe signal will display in panel)
5. Set the desired internal temperature using the **number pad**. (The default temperature is 150 °F).

Available temperatures	100 °F to 200 °F
------------------------	------------------

6. If you want to use Cook Time, Delay Start, or Keep Warm, set each function.
7. Touch **START**.
8. When the desired internal temperature is reached, the function automatically stops and an alarm sounds.

### ⚠ CAUTION

To protect the Temp Probe's tip, be careful not to insert the probe so that the tip protrudes through the surface of the meat. Make sure that the tip is in or near the center of the meat.

### ⚠ CAUTION

- Do not store the probe in the oven.
- Do not leave the probe inside the oven during a self-cleaning or broiling cycle. You can permanently damage the probe and it will no longer work.
- To avoid breaking the probe's tip, defrost your food completely.
- Do not use tongs when inserting or removing the probe. Tongs can damage the probe.
- Use the Temp Probe for Temp. Probe function cooking only. Do not use the Temp Probe for any other purpose.

### 📖 NOTE

- If you remove the Temp Probe while the Temp. Probe function is operating or insert the Temp Probe while baking or cooking normally, cooking will stop after 1 minute.
- If you use the probe to cook frozen food, there are times when it cannot be detected. (The Temp. Probe icon doesn't show in the display.)

### Temp Probe table

Type of Food		Internal temperature
Beef/Lamb	Rare	140 °F
	Medium	160 °F
	Well done	170 °F
Pork		170 °F
Poultry		180-185 °F

#### NOTE

If you cover the meat with aluminum foil and allow it to stand for 10 minutes after cooking, the Internal temperature will rise 5-10 degrees.

#### Removing the Temp Probe

Remove the temp probe plug from the socket.

#### CAUTION

After cooking, the Temp Probe is hot enough to cause burns.

### Temp Adjust

The temperature in the oven has been calibrated at the factory. When first using the oven, be sure to follow recipe times and temperatures. If you think the oven is too hot or too cool, you can correct the temperature in the oven. Before correcting, test a recipe by using a temperature setting that is higher or lower than the recommended temperature. The baking results should help you to decide how much of an adjustment is needed.

The oven temperature can be adjusted  $\pm 35$  °F ( $\pm 19$  °C).

#### How to correct the oven temperature

1. Touch **SETTING** in standby continuously until **SET CALI** display in panel, touch **START** to save. Default cook function is **BAKE**, you can set other function.
2. Enter the adjustment you want to make using the **number pad**. (0-35). If need minus -, touch **SETTING** again.
3. Touch **START** to save the changes.

#### NOTE

This adjustment will not affect the broiling or the self-cleaning temperatures.

The adjustment will be retained in memory after a power failure.

#### Temp Unit (Fahrenheit or Celsius temperature selection)

You can program the oven control to display the temperature in Fahrenheit or Celsius. The oven has been preset at the factory to display in Fahrenheit.

#### How to change the display from Fahrenheit to Celsius or Celsius to Fahrenheit

1. Touch **SETTING** in standby continuously until **SET □/□** display in panel, touch **START** to save.
2. Touch **SETTING** to change between (Fahrenheit) and (Celsius).
3. Touch **START** to save the changes.

#### Time of Day (12hr/24hr)

The oven control can be programmed to display time of day in the 12 hour or 24 hour mode.

The oven has been preset at the factory to display in the 12 hour mode.

#### How to change between the 12 and 24 hour time of day display

1. Touch **SETTING** in standby continuously until **SET 24 Hr** display in panel, touch **START** to save.
2. Touch **SETTING** to change between (12Hr) and (24 Hr).
3. Touch **START** to save the changes.

## Operating the oven

### Sound On/Off

Using Sound On/OFF, you can set the oven controls to operate silently.

#### How to turn the sound on or off

1. Touch **SETTING** in standby continuously until **SET BEEP** display in panel, touch **START** to save.
2. Touch **SETTING** to change between (ON BEEP) and (OFF BEEP) .
3. Touch **START** to save the changes.

### Demo mode

This option is for use by retail establishments for display purposes only.  
(When Demo mode is on, the heating element is disabled and does not operate.)

#### How to enable or disable the demo mode

1. Touch **SETTING** in standby continuously until **SET DISP** display in panel, touch **START** to save.
2. Touch **SETTING** to change between (ON DISP) and (OFF DISP) .
3. Touch **START** to save the changes.

## Maintaining your appliance

### Self-cleaning

This self-cleaning oven uses high temperatures (well above cooking temperatures) to burn off leftover grease and residue completely or reduce them to a finely powdered ash that you can wipe away with a damp cloth.

#### CAUTION

- During the self-cleaning cycle, the outside of the oven will become very hot to the touch. **Do not** leave small children unattended near the appliance.
- Some birds are extremely sensitive to the fumes given off during the self-cleaning cycle of any oven. Move birds to another well-ventilated room.
- **Do not** line the oven walls, racks, bottom, or any other part of the oven with aluminum foil. Doing so will result in poor heat distribution, poor baking results, and cause permanent damage to the oven interior. Aluminum foil will melt and adhere to the interior surface of the oven.
- The oven door locks during self-cleaning. **Do not** force the oven door open. This can damage the automatic door locking system. Use care when opening the oven door after the self-cleaning cycle is complete. Stand to the side of the oven when opening the door to allow hot air or steam to escape. The oven may still be **VERY HOT**.



# Maintaining your appliance

## Before a self-cleaning cycle

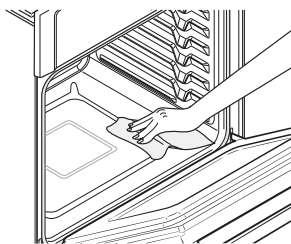

Fig. 1

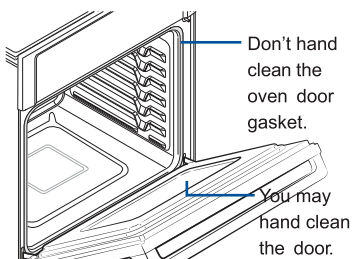

Fig. 2

- We recommend venting your kitchen with an open window or using a ventilation fan or hood during the self-cleaning cycle.
- Remove the wire rack, broil pan, broil pan insert, all cookware, and any aluminum foil from the oven.
- Wipe up debris from the oven bottom.(Fig. 1)
- The silver-colored oven racks can be self-cleaned, but they will darken, lose their luster, and become hard to slide.
- Residue on the front frame of the oven and outside the gasket on the door will need to be cleaned by hand. Clean these areas with hot water, soap-dilled steel-wool pads, or cleansers such as Soft Scrub. Rinse well with clean water and dry.
- Do not clean the gasket. The fiberglass material of the oven door gasket cannot withstand abrasion. It is essential for the gasket to remain intact. If you notice it becoming worn or frayed, have it replaced. (Fig. 2)
- Make sure the oven light cover is in place and the oven light is off.

### NOTE

Remove oven racks and accessories before starting the self-clean mode.

## How to run a self-cleaning cycle

1. Select the length of time for the self-cleaning operation, eg. 3 hours. Touch Self Clean 2/3/5h once for a 3 hour clean time, twice for a 5 hour clean time, or 3 times for a 2 hour clean time. The default setting is 3 hours.
2. Touch START to start the self-cleaning cycle. The motor-driven door lock will engage automatically.

### NOTE

- You will not be able to start a self-cleaning cycle if the Control Lockout feature is activated or if the oven's temperature is too hot.
  - The oven door locks automatically. The display will show the cleaning time remaining. You cannot open the oven door until the temperature drops to a safe/cool temperature.
3. When the self-cleaning cycle is done, End will appear in the display and the oven will beep 6 times.

## How to delay the start of self-cleaning

1. Touch Self Clean 2/3/5h. Select the desired self-clean time by touching Self Clean 2/3/5h.
2. Touch Delay Start.
3. Enter the time you want the self-clean cycle to start.
4. Touch START. The display will show Delay, Self clean, and the Lock icon. The motor-driven door lock will engage automatically.
5. The Self-Cleaning cycle will turn on automatically at the set time.

## How to turn off the self-cleaning feature

If you need to stop or interrupt a self-cleaning cycle:

1. Touch Cancel.
2. You will be able to open the oven door once the oven has cooled down for approximately 1 hour.

## After a self-cleaning cycle

- You may notice some white ash in the oven. Wipe it up with a damp cloth after the oven cools. (If white spots remain, remove them with a soap-filled steel wool pad and rinse thoroughly with a vinegar and water mixture.)
- If the oven is not clean after one cycle, repeat the cycle.
- You cannot set the oven for cooking until the oven is cool enough for the door.

## Using Sabbath

You can use the Sabbath feature with baking only. The oven temperature may be set higher or lower after setting the Sabbath feature. (The oven temperature adjustment feature should be used only during Jewish holidays.) The display, however, will not change and tones will not sound when a change occurs. Once the oven is properly set for baking with the Sabbath feature active, the oven will remain continuously on until the Sabbath feature is cancelled. If the oven light is needed during the Sabbath, touch Light before activating the Sabbath feature. Once the oven light is turned on and the Sabbath feature is active, the oven light will remain on until the Sabbath feature is turned off. If the oven light needs to be off, be sure to turn the oven light off before activating the Sabbath feature.

### How to use the Sabbath feature

- Touch Bake. The default temperature is 350 °F.
- Enter the temperature you want, eg. 375 °F, by using the number pad.
- Touch START. The temperature display will start to change once the oven temperature reaches 100 °F.
- Touch Bake and Broil for three seconds at same time. The panel will display Set Sab.
- Touch START. Activate the oven Sabbath function, the panel will display SAb, the oven heating work automatically becomes 74 hours. Once SAb appears in the display, the oven will not beep or display any further changes. You may change the oven temperature once baking has started. Remember that the oven will not beep or display any further changes once the Sabbath feature is engaged.
- You can turn the oven off at any time by touching Cancel. This will turn only the oven off. If you want to deactivate the Sabbath feature, hold down Cancel for 3 seconds. Sab will disappear from the display.

### NOTE

Do not to attempt to activate any other program feature except BAKE while the Sabbath feature is active. ONLY the following key pads will function correctly with the Sabbath feature on: NUMBER, BAKE, START and Cancel. All other keypads should not be used once the Sabbath feature is activated.

- ✓ You can change the oven temperature, but the display will not change and tones will not sound when a change occurs. (The oven temperature adjustment feature should be used only on Jewish holidays.) After changing the temperature while the unit is in Sabbath mode, there is a 15 second delay before the unit recognizes the change.
- ✓ Should you experience a power failure or interruption, the oven will shut off. When power is returned, the oven will not turn back on automatically. SAb will be displayed in the oven's control display, but the oven will not operate. Food may be safely removed from the oven while it is still in the Sabbath mode, however the oven cannot be turned back on until after the Sabbath/ Holidays. After the Sabbath observance, turn off the Sabbath mode. Touch and hold down Cancel for 3 seconds simultaneously to turn the Sabbath mode off. The oven may then be used with all normal functions.

Do not open the oven door or change the oven temperature for about 30 minutes after you have started Sabbath mode to allow the oven to reach the set temperature.

## Self-cleaning

Cleaning painted parts and decorative trim

- For general cleaning, use a cloth with hot, soapy water.
- For more difficult residue and built-up grease, apply a liquid detergent directly onto the area and leave for 30 to 60 minutes. Wipe with a damp cloth and dry. Do not use abrasive cleaners on any oven surface. They can be scratched.

### Cleaning stainless steel surfaces

- Shake a bottle of Stainless Steel Appliance Cleaner or Polish well.
- Place a small amount of stainless steel appliance cleaner or polish on a damp cloth or damp paper towel.
- Clean a small area, rubbing with the grain of the stainless steel if applicable.
- Dry and buff with a clean, dry paper towel or soft cloth.
- Repeat as necessary.

### NOTE

- Do not use a steel-wool pad. It will scratch the surface.
- If a mineral oil-based stainless steel appliance cleaner has been used before to clean the appliance, wash the surface with dishwashing liquid and water prior to using the Stainless Steel Appliance Cleaner or Polish.

### Oven racks

- If the racks are left in the oven during a self-cleaning cycle, their color will turn slightly blue and the finish will be dull. After the self-cleaning cycle is complete and the oven has cooled, rub the sides of the racks with wax paper or a cloth containing a small amount of oil. This will help the racks glide more easily on their tracks.
- Gliding racks may be cleaned by hand with an abrasive cleaner or steel wool. During cleaning, be careful not to allow water or cleaner to enter the slides on the sides of rack.

### Oven door

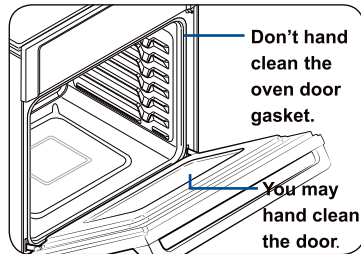

- Use soap and water to thoroughly clean the top, sides, and front of the oven door. Rinse well. You may use a glass cleaner on the outside glass of the oven door. **DO NOT** immerse the door in water. **DO NOT spray or allow water or the glass cleaner to enter the door vents.** **DO NOT** use oven cleaners, cleaning powders, or any harsh abrasive cleaning materials on the outside of the oven door.
- **DO NOT clean the oven door gasket.** The oven door gasket is made of a woven material which is essential for a good seal. Care should be taken not to rub, damage, or remove this gasket.

## Maintaining your appliance

### Removing the oven doors

#### CAUTION

- The door is very heavy. Be careful when removing and lifting the door.
- Do not lift the door by the handle. Use two hands to remove an oven door. For double ovens, repeat the process for each door.

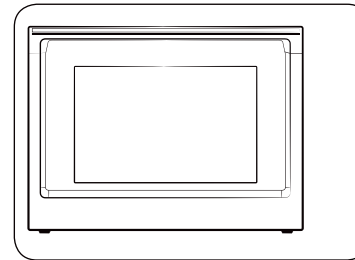

1. Prior to removing the oven door, prepare a surface where you will place covered with a soft blanket. You can also use the corner posts from your packaging material.

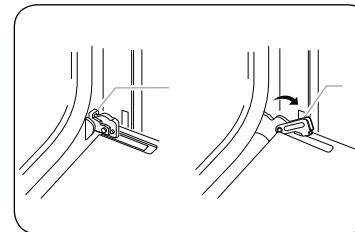

- A. Oven door hinge lock in locked position
- B. Oven door hinge lock in unlocked position

2. Open the oven door.
3. Locate the oven door hinge locks in both corners of the oven door, and then rotate the hinge locks toward the oven door to the unlocked position. If the door hinge lock is not rotated fully (see illustration B on the left for an example of full rotation), you will not be able to remove the door properly.

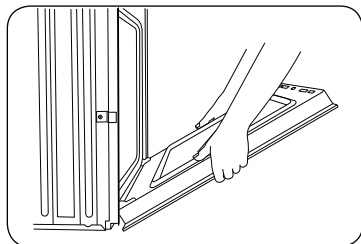

- Partially close the door to engage the door latch locks.  
The door will stop at this point.

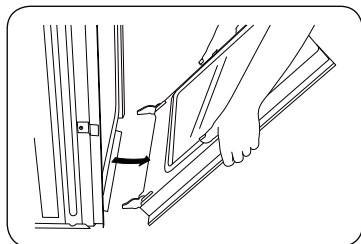

- Using two hands, grasp the edges of the oven door. Lift and pull the oven door toward you and remove. You may need to gently shift the door from side to side as you pull.
- Set the oven door aside on the prepared covered work surface with the oven door resting on its handle.

## Replacing the oven door

### CAUTION

The door is very heavy. You may need help lifting the door high enough to slide it into the hinge slots. Do not lift the door by the handle.

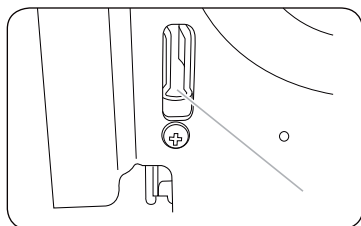

A. Slot in the oven cavity for the door hinge lock

- Using two hands, grasp the side edges of the door at the midpoint.  
Face the oven cavity.
- Locate the slots on each side of the oven cavity for the door hinge locks.

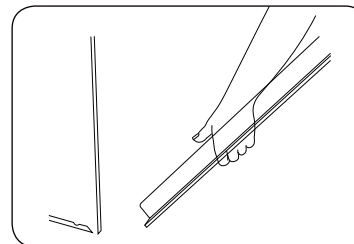

- Hold the door at a 45° angle, and then align the door hinges with the slots in the lower front of the oven cavity. Slowly insert the door, making sure you maintain the 45° angle. You will know the door is engaged in the slot when you feel a slight drop.

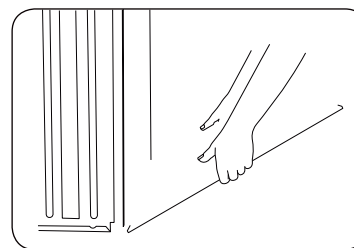

- Lower the oven door to the fully open position. If the oven door does not open to a full 90°, repeat steps 1 through 3.
- Locate the oven door hinge locks in the corners of the oven door, and rotate the hinge locks toward the oven cavity to the locked position.  
[See Step 3 \(illustration A\) in the “Removing the oven doors” section for the proper locked position.](#)
- Close the oven door.
- When the hinges are properly installed and the door is closed, there should be an even gap between the door and the control panel. If one side of the oven door is hanging lower than the other, the hinge on that side is not properly installed.

# Troubleshooting

## Troubleshooting

Empava works hard to ensure that you don't have problems with your new electric oven. If you run into unexpected trouble, look first for a solution in the tables below. If you're still having trouble after trying the suggested solution, call Empava at 1-888-682-8882.

### CONTROL DISPLAY

Problem	Possible cause	Solution
The display goes blank.	A fuse in your home may be blown or the circuit breaker tripped.	Replace the fuse or reset the circuit breaker.
The buttons cannot be pressed properly.	<ul style="list-style-type: none"> <li>There is foreign matter caught between the buttons</li> <li>Touch model: There is moisture on the exterior</li> <li>The lock function is set</li> </ul>	<ul style="list-style-type: none"> <li>Remove the foreign matter and try again.</li> <li>Remove the moisture and try again.</li> <li>Check whether the lock function is set.</li> </ul>

## OVEN

Problem	Possible cause	Solution
The oven will not turn on.	The oven is not completely plugged into the electrical outlet.	Make sure the electrical plug is inserted into a live, properly grounded outlet.
	A fuse in your home may be blown or a circuit breaker may have tripped.	Replace the fuse or reset the circuit breaker.
	The oven controls have been set improperly.	See the chapter on operating the oven starting on page 21.
	The oven is too hot.	Allow the oven to cool.
	Incomplete service wiring.	Call for service.
The oven light will not turn on.	Power outage.	Check to see if the house lights will turn on. If necessary, call your local electric company for service.
	The light is loose or defective.	<ul style="list-style-type: none"> <li>Tighten or replace the lamp.</li> <li>Call for service if the door light does not turn on.</li> </ul>
	The switch operating the light is broken.	Call for service.

Problem	Possible cause	Solution
<b>The oven smokes excessively during broiling.</b>	The oven controls have not been set properly.	Refer to the section on operating the oven on page 21.
	The meat has been placed too close to the element.	Reposition the rack to provide proper clearance between the meat and the element. Preheat the broil element for searing.
	The meat has not been properly prepared.	Remove excess fat from the meat. Cut away fatty edges that may curl, leaving the lean intact.
	Grease has built up on oven surfaces.	Regular cleaning is necessary when broiling frequently.
<b>Food does not bake or roast properly.</b>	The oven controls have not been set correctly.	See the chapter on operating the oven starting on page 21.
	The oven rack has been positioned incorrectly or is not level.	See the section on using the oven racks on page 25.
	Incorrect cookware or cookware of improper size is being used.	
	The oven thermistor needs to be adjusted.	See the Temp Adjust section on page 30.

Problem	Possible cause	Solution
<b>Food does not broil properly.</b>	The serving size may not be appropriate.	Refer to the Broiling recommendation guide for serving sizes on page 29, and then try again.
	The rack has not been properly positioned.	See the Broiling recommendation guide on page 29.
	The cookware is not suited for broiling.	Use suitable cookware.
	In some areas, the power (voltage) may be low.	<ul style="list-style-type: none"> <li>• Preheat the broil element for 10 minutes.</li> <li>• See the broiling recommendation guide on page 29.</li> </ul>
<b>The oven temperature is too hot or too cold.</b>	The oven sensor needs to be adjusted.	See the section on adjusting the thermostat on page 31.
<b>There is water dripping.</b>	You may see water or steam in some cases depending on the food you are cooking. This is not a product malfunction.	Let the oven cool and then wipe with a dry dish towel.
<b>There is steam coming through the crack between the oven body and the door.</b>		
<b>Water is remaining in the oven.</b>		

# Troubleshooting

Problem	Possible cause	Solution
The oven will not self-clean.	The oven temperature is too high to start a self-clean operation.	Allow the oven to cool and then reset the controls.
	The oven controls have been set incorrectly.	See the section on selfcleaning on page 35.
	A self-cleaning cycle cannot be started if the oven lockout feature has been activated.	Deactivate the oven lockout (see page 34).
Excessive smoking during a self-cleaning cycle.	There is excessive soiling in the oven.	Touch <b>Cancel</b> . Open the windows to rid the room of smoke. Wait until the selfcleaning cycle is cancelled. Wipe up the excessive soil and then start the selfcleaning cycle again.
The oven door will not open after a selfcleaning cycle.	The oven is too hot.	Allow the oven to cool.
The oven is not clean after a self-cleaning cycle.	The oven controls were not set correctly.	See the section on selfcleaning on page 34.
	The oven was heavily soiled.	Wipe up heavy spillovers before starting the selfcleaning cycle. Heavily soiled ovens may need to be self-cleaned again or for a longer period of time.

Problem	Possible cause	Solution
Steam is coming out of the vent.	When using the convection feature, it is normal to see steam coming out of the oven vent.	This is normal operation and not a system failure. Use the oven as usual.
	As the number of racks or amount of food being cooked increases, the amount of visible steam will increase.	
A burning or oily odor is coming from the vent.	This is normal for a new oven and will disappear in time.	<ul style="list-style-type: none"> <li>To speed the process, set a self-cleaning cycle for a minimum of 3 hours.</li> <li>See the section on selfcleaning on page 34.</li> </ul>
Strong door.	An odor coming from the insulation around the inside of the oven is normal for the first few times the oven is used.	Operate the oven empty on the bake setting at 400 °F for 1 hour.
The oven door is locked.	The circuit breaker has been tripped or there was a power failure while the oven door was locked.	Activate Control Lockout, and then unlock the control. See the <b>Control Lockout</b> section on page 22.

## Information codes

### OVEN

Error Code	Error Code Description	Cause for the Error Code	After Sales Service
E0	The main circuit board can not detect the temperature sensor (k-type thermocouple )	1.The temperature sensor (k-type thermocouple ) may be damaged and circuit open	Replace the temperature sensor (k-type thermocouple )
		2.Possibly poor contact between the temperature sensor (k-type thermocouple ) and the connector at the CN2 position of the circuit board	Replace the connector
		3.The IC at the IC5 position of the circuit board may be damaged.	Replace the control board
E1	A failure of the oven door circuit	1. The door status detection switch may be damaged	Replace the switch
		2.The door detection switch wire group plug and the connector at the CN1 6position of the circuit board may be in poor connection	Replace the connector
		3.Poor contact of switch S1	Press the port tightly and reinsert the switch
		4.The circuit and components of the circuit board may be damaged.	Replace the circuit board
E2	The oven heats up slowly after it starts to heat up	1.The display may be damaged	Replace the circuit board
		2.The power board may be damaged	Replace the circuit board
		3.Possibly poor contact between the plug of the wire set and the connector at the CN18 position of the power board.	Replace the connector
		4.Possibly poor contact between the plug of the wire set and the connector at the CN2 position of the display board.	Replace the connector
E3	After the oven door was latched, it was detected that the oven door was opened.	1.The door detection switch S1 is broken.	Replace the switch at door latch S1position
		2.The circuit board is broken.	Replace the circuit board
		3.The pin wire connector of the door switch S1 is loose.	After pressing the connector, reinsert the corresponding pin of the switch
E4	The oven temperature is too high even not under self-cleaning function	1.Possibly poor contact between the circuit and components of the main control circuit board.	Replace the circuit board
		2.The cooling fan is broken.	Replace the cooling fan
		3.Possibly poor contact between the wiring terminal of the wire set and the connector at the CN3 position of the circuit board.	Replace the connector
		4.The thermal protector K2 or K3 is broken.	Replace the thermal protector K2 or K3
		5.Possibly poor contact between the wiring terminal of the wire set and the connector at the CN7 position of the circuit board.	Replace the connector
E5	After preheating for 10 minutes,oven temperature without change.	1.The electronic components of the main control circuit board are broken	Replace the circuit board
		2.Electric range only: heating elements broken	
		3.Electric range only: AC 240V powered off	
		4.The thermal protector K2 or K3 is broken.	

Error Code	Error Code Description	Cause for the Error Code	After Sales Service
E6	When oven under preheat, the temperature will no longer rise after the previous rised.	1.The electronic components of the circuit board are broken	Replace the circuit board
		2.Electric range only: heating elements broken	Replace the heating element
		3.The oven door switch is broken, causing the circuit to misjudge that the door is open, so the oven stops heating.	Replace the oven door switch
E7	When the oven is heating, the temperature keeps falling.	1.The electronic components of the circuit board are broken	Replace the circuit board
		2.Electric range only: heating elements broken	Replace the heating element
		3.The oven door switch is broken, causing the circuit to misjudge that the door is open, so the oven stops heating.	Replace the oven door switch
E8	The oven door can not be locked	1.The electronic components of the circuit board are broken	Replace the circuit board
		2.The latch motor is broken.	Replace the latch motor
		3.If it is in the unlocking process, the micro switch at the S2 position of the door latch is broken.	Replace the switch at door latch S2 position
		4.If it is in the unlocking process, the micro switch at the S3 position of the door latch is broken.	Replace the switch at door latch S3 position
E9	AC power 120V/240V frequency 50Hz/60Hz is abnormal	1.The electronic components of the circuit board are broken	Replace the circuit board
		2.AC power 120V/240V frequency 50Hz/60Hz is abnormal	Power off for 30 seconds and power on again.
E10	The main control chip SH79F326 is broken internally	1.The main control chip SH79F326 is broken internally	Replace the circuit board
E14	NTC on the main control circuit board is open or shorted	1. NTC on the main control circuit board is broken	Replace the circuit board
E15	The ambient temperature of the main control circuit board is too high	1.The room ambient temperature is too high, causing the oven temperature to rise too high.	Indoor ventilation and cooling
		2.The NTC thermistor is aging and invalid, causing the temperature to be inaccurate.	Replace the circuit board
E16	Food probe short circuit	1.The electronic components of the circuit board are broken	Replace the circuit board
		2. Food probe is broken	Replace the food probe
		3.The food probe connector is broken	Replace the food probe connector



# Warranty and Service

## Warrant & Service

This product has been manufactured by Empava appliance inc. 115253 Don Julian Rd, City of industry, CA, 91745. Empava disclaims all express warranties except for the following:

This warranty applies to products purchased and located in the United States. Products purchased or located outside this area are excluded.

The warranty does not apply to damage resulting from abuse, accident, natural disaster, loss of electrical power to the product for any reason, alteration, outdoor use, improper installation, and improper operation, repair or service of the product by anyone other than an authorized Empava service agency or representative.

## Warranties and Duration

Warranty : 2 year Parts and Labor

Implied warranties terminate upon expiration of the limited warranty. Some states do not allow limitations on how long implied warranty lasts, so the above limitation may not apply to your implied warranty.

## Empava will pay for:

All repair labor and cost of replacement parts found to be defective due to material and workmanship. Service must be provided by a Empava Authorized Service Agency during normal working hours.

For a Service Agency nearest you, please call 1-888-682-8882 or email to Support@empava.com

## Empava will not pay fo

This limited warranty does not cover

1. Service to instruct you on how to use your range to correct house wiring, replace or repair house fuses. Service to correct the installation of your range.
2. Repairs when your range is used for other than normal, single-family household use or when it is used in a manner that is contrary to published user or operator instructions and/or installation instructions.
3. Cosmetic damage, including chips, dents, scratches or other damage to the finish of your range, unless such damage results from defects in materials or workmanship and is reported to Empava within 30 days from the date of purchase.
4. Costs associated with the removal from your home of your range for repairs. This range is designed to be repaired in the home and only in-home service is covered by this warranty.
5. Damage resulting from misuse, alteration, accident, abuse, fire, flood, acts of God, improper installation, installation not in accordance with electrical, or use of consumables or cleaning products not approved by Empava.
6. Service to repair or replace consumable parts. Consumable parts are not included in the warranty coverage.
7. The removal and re-installation of your range if it is installed in an inaccessible location or is not installed in accordance with published installation instructions.

8. This warranty is void if the factory applied serial number has been altered or removed from your range.

9. Repairs to parts or systems resulting from unauthorized modifications made to the appliance.

10. Expenses for travel and transportation for product service if your range is located on a remote area where service by an authorized Empava service provider is not available.

The warranty applies to appliances purchased and used for personal, family or household purposes only. It does not cover appliances used for commercial applications. Should the appliance be sold by the original purchaser during the warranty period, the warranty shall extend to the new owner until the expiration date of the original purchaser's warranty period.

## Warranty and Product Registration

Empava is not responsible for incidental or consequential damages. Under no circumstances will Empava's liability exceed the cost that you paid for the product. Some states do not allow the exclusion or limitation of incidental or consequential damages, so the above limitations or exclusion may not apply to you.

This warranty gives you specific legal rights, and you may also have other rights that vary from state to state. Whenever you call our customer service at (Empva appliance inc) for technical information and parts sales in the United States or to request service for your appliance, please have your complete model number and serial number ready. The model and serial number can be found on the product data plate. Please enter the information requested in the spaces provided.

Model No. \_\_\_\_\_ Serial No. \_\_\_\_\_

Date of Purchase \_\_\_\_\_ Purchaser \_\_\_\_\_

Dealer \_\_\_\_\_ Suburb \_\_\_\_\_

Town \_\_\_\_\_ Country \_\_\_\_\_

Note: You must provide proof of purchased or installation date for in-warranty service.